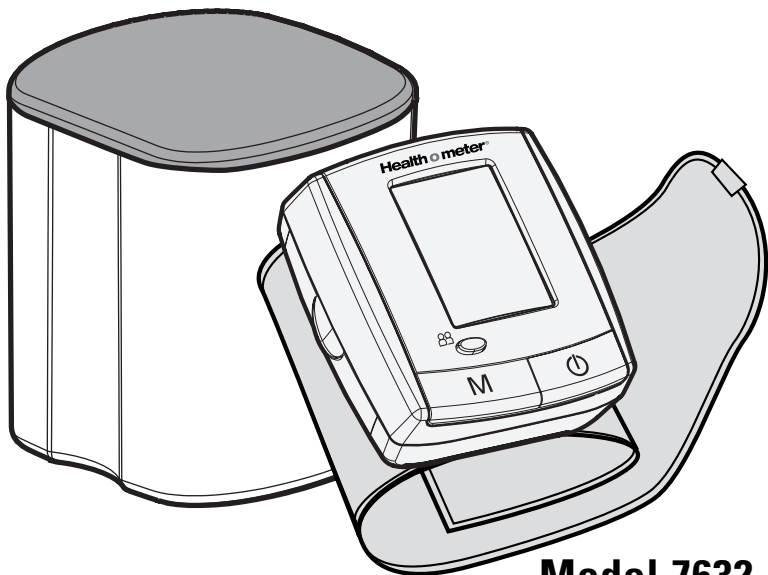


# Health o meter<sup>®</sup>

*Your Measure for Good Health™*

AUTOMATIC WRIST  
**Blood Pressure  
Monitor**



**Model 7632**

## **IMPORTANT NOTES**

**Please read this entire manual carefully before using this device.**

# Health o meter®

## Automatic Wrist Blood Pressure Monitor

### IMPORTANT SAFETY INSTRUCTIONS

**DO NOT DESTROY**

#### Features:

- **One-Touch Easy Operation**
- **Large, Easy-To-Read Digital Display**
- **Two-User Memory Feature**
- **50 Automatic Memory Readings for Each User**
- **MicroStep™ Technology Precisely Controls Deflation for Greater Accuracy**
- **Date and Time Indication**
- **Auto Shut-Off**
- **Convenient Storage Case**
- **Compact and Portable**

*In accordance with International Standards:*

**CE** **ISO**  
0366 9001

## Table of Contents

Introduction .....	4
Quick Reference Guide .....	5
Standards of Quality .....	6
About the Wrist Monitor .....	6
About Blood Pressure .....	6-7
Blood Pressure Standard .....	7
Blood Pressure Fluctuation .....	7
Carrying Case .....	8
Product Component Identification .....	8
Display Explanations .....	9
Installing Batteries .....	9-10
Setting the Time .....	10
HOW TO USE .....	11-15
• Helpful Tips .....	11
• Applying the Cuff .....	11
• Proper Posture During Measurement .....	12
• Taking a Measurement .....	13-14
• Recalling Memory .....	14-15
• Clearing Values from Memory .....	15
Troubleshooting .....	16
Precautionary Notes .....	17
Specifications .....	18
Patents .....	18
Warranty Information .....	19
Blood Pressure Log .....	20-21

# Introduction

Congratulations on your purchase of the new Health o meter® Wrist Blood Pressure Monitor Model 7632. This fully-automatic, wrist-mounted device is both easy to use and ideally suited for daily measurements. The large display includes systolic, diastolic and pulse measurements, all clearly shown at the completion of each reading. With its enhanced, comprehensive features, this Health o meter® monitor will be the only blood pressure monitor you will need for your family.

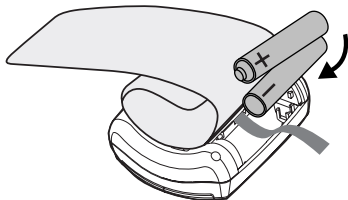
With this blood pressure monitor, you can store up to 50 measurements into 2 Memory Zones, one for each user. This device is ideal for users who want to monitor and track their blood pressure on a regular basis. The Health o meter® blood pressure monitor is compact and portable, making it ideal for both home and travel usage.

Blood pressure measurements determined with the Health o meter® blood pressure monitor are equivalent to those using the cuff/stethoscope auscultation method and are within the limits prescribed by the American National Standards Institute (ANSI). This monitor is to be used by an adult and is intended for in-home use.

Note: Please read this manual carefully before use. For specific information about your own blood pressure, contact your physician. Please be sure to keep this manual for future reference.

# Quick Reference

## A. Installing Batteries



Battery Type: 2 AAA 1.5 Volt  
(See Page 9)

## B. Applying the Cuff



Apply cuff to **LEFT** wrist with  
**PALM FACING UP.**  
(See Page 11)

## C. Correct Posture

Place the wrist at heart level.  
(See Page 12) Relax a few minutes  
before starting the Blood Pressure  
Monitor. (See Helpful Tips, Page 11)

## D. Press ON/OFF/START Button

Remain still during measurement.  
This unit will automatically inflate  
then deflate. (See Page 13)

## E. Automatic Memory

Your new Health o meter<sup>®</sup> monitor  
stores a maximum of 50 measured  
values for up to 2 users. The symbol  
“mem” will blink when measurement  
is completed and stored in memory.  
(See Page 14)

## F. Recall Memory

Use **User-Selection** button to  
select a Memory Zone, then press “**M**”  
to recall prior measured values from  
that Memory zone. (See Page 14)

## Standards of Quality

This Blood Pressure Monitor conforms with the American National Standards Institute/American Association of Medical Instrumentation Standards for Non-Invasive Blood Pressure Monitors. In addition, the device complies with the European regulations and bears the CE mark "CE 0366". The quality of the device has been verified and conforms to the provisions of the EC council directive 93/42/EEC dated 14 June 1993 concerning medical devices, as well as the EMC directive 89/336/EEC:

ANSI/AAMI SB10	Electronic or automated Sphygmomanometers
EN 1060-1 (Dec. 1995)	Non-invasive blood pressure measuring equipment General requirements
EN 1060-3 (Feb. 1997)	Non-invasive blood pressure measuring equipment Supplementary requirements for electromechanical blood pressure measuring systems

## About the Wrist Blood Pressure Monitor

Your Health o meter<sup>®</sup> blood pressure monitor uses the oscillometric method to detect your blood pressure. Before the cuff starts inflating, the device will establish a baseline cuff pressure, which is equivalent to the air pressure. The measurement of your blood pressure is based on this baseline pressure. Once the cuff inflates to block the passage of blood in the artery, the deflation process begins. During the deflation of the wrist cuff, the unit is detecting the pressure oscillations generated between beats of the pulse. Any muscle movement during this period of time will cause measurement error. After detecting the amplitude and the slope of the pressure oscillations during the deflation process, your Health o meter<sup>®</sup> monitor will determine the systolic and diastolic pressures for you. Your pulse rate is detected and displayed at the same time.

## ABOUT BLOOD PRESSURE

### What is Blood Pressure?

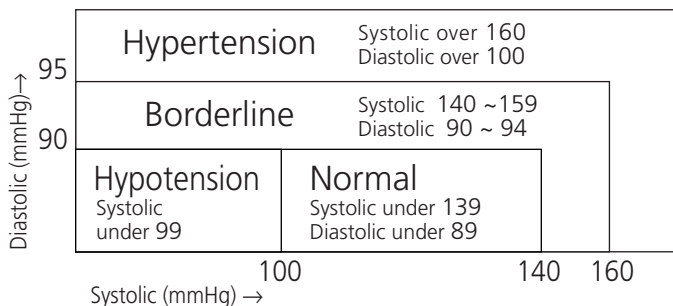
Blood pressure is the pressure exerted on the inside of the artery wall while blood flows through the artery. The pressure measured when the heart contracts and sends blood out of the heart is the "systolic" reading (higher number). The pressure measured when the heart dilates with blood flowing back into the heart is called the "diastolic" (lowest number) blood pressure.

## Why Measure Your Blood Pressure?

Various health problems associated to high blood pressure are quite common with people in today's society. There is a significant correlation of high blood pressure with cardiovascular disease. This correlation has made measuring blood pressure a necessity for those individuals identified with high blood pressure, placing them into a high risk category pertaining to cardiovascular disease. Also, as a person ages, one's blood pressure can change over time, thus it makes good "health sense" to monitor your blood pressure on a regular basis.

## Blood Pressure Standard

The World Health Organization (WHO) has developed a blood pressure standard, according to which areas of low and high-risk blood pressure are identified. This standard, however, is a general guideline as individual's blood pressure varies among different people and different age groups, etc.

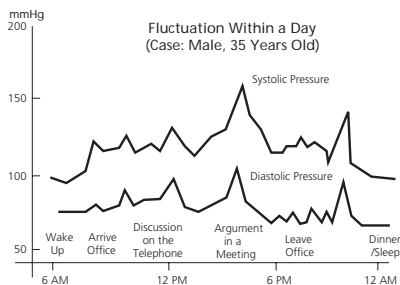


It is important that you consult with your physician regularly. Your physician can tell you your optimal blood pressure range.

## Blood Pressure Fluctuation

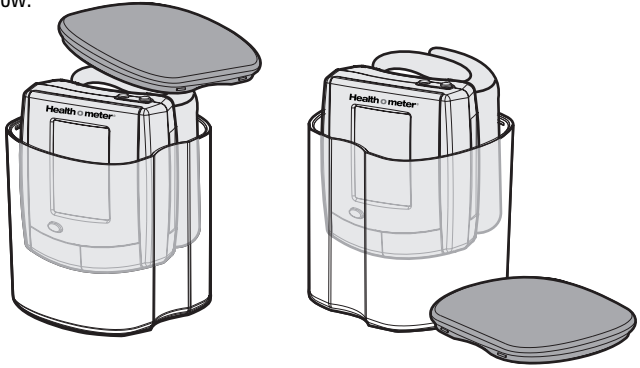
***Blood pressure fluctuates all the time!***

Your blood pressure will change over the course of the month, week and even throughout the day. It is also influenced by seasonal and temperature changes.



## Carrying Case

Please store your Health o meter® Blood Pressure Monitor in the carrying case provided as shown below:



## Product Component Identification



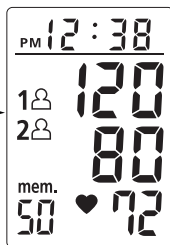
- A.** LCD Display
- B.** Memory Recall Button
- C.** Wrist Cuff
- D.** Date/Time Set Button
- E.** Power Button (for ON/OFF)
- F.** Battery Cover
- G.** User Selection Button
- H.** 2 AAA Size 1.5v Alkaline Batteries  
(Included)



## Display Explanations

### Display:

Memory  
Zones



*Date/Time Indicator*

*Systolic Pressure*

*Diastolic Pressure*

*Pulse Rate*

*No. of Memory Sequence*

### Icons:



Memory Zone 1 : Appears when the monitor is operated in memory zone 1



Memory Zone 2 : Appears when the monitor is operated in memory zone 2



Weak Battery Mark : Appears when batteries should be replaced



Pulse Mark : Shows the pulse rate per minute

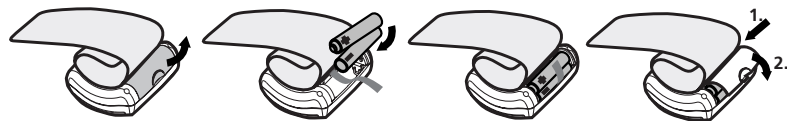


Memory Mark : Shows the number of stored measurements



Error Mark : Occurs when an error was made during measurement

## Installing Batteries



1. Place your thumb on the side of the battery cover. Pull the battery cover in the direction of the cuff to open.
2. Install lower battery first in the bottom position with the battery ribbon underneath. **Battery Type: 2 Alkaline (AAA) size.**
3. Insert the other battery and pull up the battery ribbon over it.
4. Replace the cover by placing the end tabs of the battery cover in the slots on the top of the battery compartment. Click in the other end to secure the battery cover.

## Replace the batteries if:






1. The weak battery mark appears in the display.
2. Nothing appears in the display when the power is switched on.

As the supplied batteries are for test only, they may discharge earlier than batteries you buy in stores. Replace the batteries in pairs.

Remove batteries when unit is not in use for extended periods of time.

Note:  Discard used batteries as directed by your local, environmental codes.

## Setting the Time

1. To set/adjust the date and time in the monitor, press the “Set” Button  located on the top surface of the monitor. The display will show a blinking number showing the month.
2. Change the month by pressing the  button. Each press of this button will increase the number by one in a cycling manner. Press the **Set Button**  again to confirm the entry, and the screen will show a blinking number representing the number of the day in the month.
3. Change the date, the hour and the minutes as described in Step 2 above, using the  button to change and the  button to confirm the entries.
4. A “0” will reappear as the Blood Pressure Monitor is ready for measurement again.



Press the Set Button



Month Position Will Blink



Press To Select Month



Press To Confirm Selection



# How To Use

s to help you obtain more accurate readings:  
blood pressure immediately after consuming a large meal.  
ite readings, please wait one hour before measuring.  
alcohol before measuring your blood pressure.  
sically tired or exhausted while taking a measurement.  
relax during measurement. Try to take a 15-minute rest

you are under stress or under tension.

al body temperature. If you are feeling cold or hot  
ment.

temperature (near freezing), have it placed  
before using it.

**DO NOT** blood pressure measurement.

1. Remove all watches, jewelry, etc., prior to attaching the device. Sleeves should be loosely rolled up and the cuff should be loose for correct measurements.
2. Apply cuff to left wrist with palm facing up as shown in Figure A.
3. Make sure the edge of the cuff is about 3/8 inch from the palm as shown in Figure B.



FIGURE A

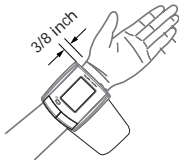


FIGURE B



FIGURE C

4. In order to insure accurate measurements, fasten the fabric fastener strap securely around your wrist so there is no extra space between the cuff and the wrist as shown in Figure C.

**Note:** If the cuff is not wrapped tightly enough, the measurement values may be false. However, do not apply the cuff too tightly as it may constrict the smooth flow of blood to the hand.

5. If your physician has diagnosed you with poor circulation on your left arm, carefully place the cuff around your right wrist as shown in Figure D.



FIGURE D

## Proper Posture During Measurement

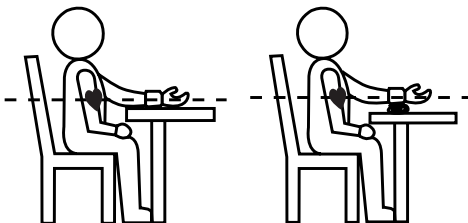
1. Place your elbow on a table so that the cuff is at the same level as your heart as shown in Figure A.

**Note:** Your heart is located slightly below your armpit and a bit to the left of the middle of your chest.

Relax your entire body, especially the area between your elbow and fingers.

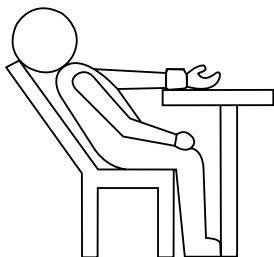


**FIGURE A**



**FIGURE B**

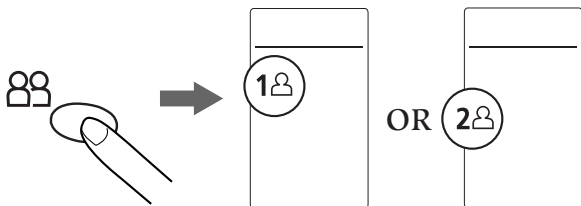
2. If the cuff is not at the same level as your heart or if you can not keep your arm completely still throughout the reading, use a soft object such as a folded towel to support your arm as shown in Figure B. Do not allow hard objects to come in contact with the wrist cuff.
3. Turn your palm upwards.
4. Sit upright in a chair, and take 5-6 deep, relaxing breaths.
5. Avoid leaning back while the measurement is being taken as shown in Figure C.




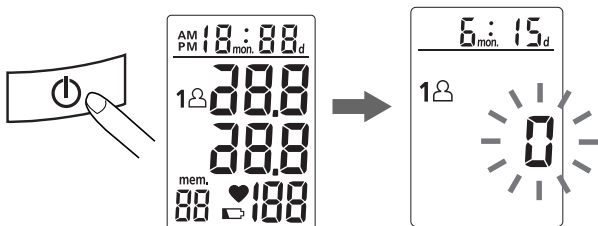
**FIGURE C**

## Taking a Measurement

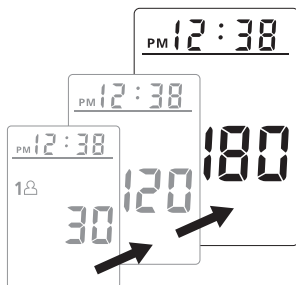
1. Press the “**User Selection**” button to select Memory Zone 1 or Memory Zone 2. The measurement that you take will automatically be stored in the Zone selected.



2. Place the cuff on the wrist. Press the “**ON/OFF/START**” button . All digits will light up, checking the display functions. The checking procedure will be completed after about 2 seconds.

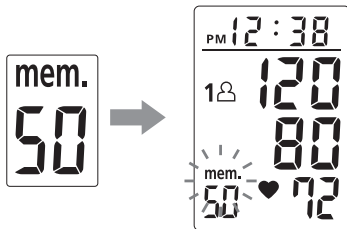


3. After all symbols appear, the display will show a blinking “0”. The monitor is “**Ready to Measure**” and will **automatically** inflate the cuff to start measurement.



This monitor will re-inflate automatically to **approximately 220mmHg** if the system detects that your body needs a higher pressure to measure your blood pressure.

- When the measurement is completed, systolic, diastolic, and pulse will be shown simultaneously and be saved automatically into the memory. The measurement is then automatically stored into the pre-designated memory zone. **The last 50 measurement readings will be saved into each memory.**

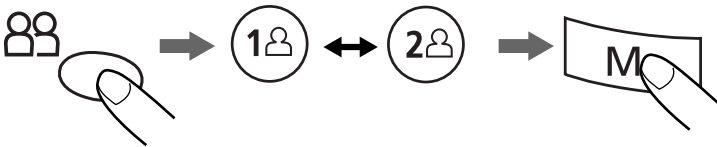


### Note:

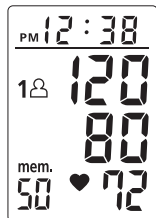
- This monitor automatically switches off approximately **1 minute** after the last button operation.
- To interrupt the measurement, simply press any key. The cuff will deflate immediately after a key is pressed.
- During the measurement, do not talk or move your arm or hand muscles.

### Recalling Values from Memory

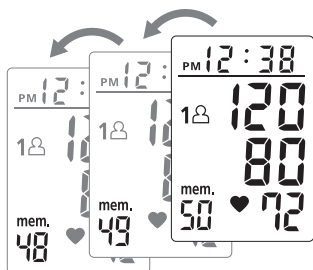
- The monitor has two memory zones (1 and 2). **Each zone can store up to 50 measurements.**



- To recall blood pressure readings from memory, use the **“User-Selection”** button to select the appropriate Memory Zone (1 or 2) from which to recall the readings. Once the proper zone is selected, press the **“M”** button. The memory values will be shown on the LCD display.

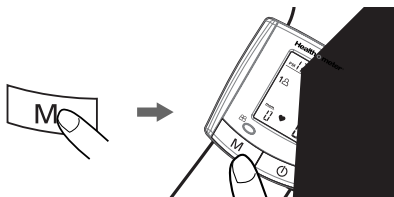


- Every new press of the “M” button recalls one set of prior stored values. The most recent memory readings will be recalled first.



## Clearing Values from Memory

- Press the “User-Selection” button to select Memory Zone 1 or Memory Zone 2.
- Continue to press the “M” button for approximately 5 seconds, then the data in the selected memory zone will be erased automatically.



Press the “M” button for 5 seconds to clear all memory

Note: The data in both Memory Zones (Zone 1 and Zone 2) will be erased if one or both batteries are removed from the battery compartment. *(Please remember to record your previous readings [from both zones] into your Blood Pressure Log prior to replacing the batteries.)* You can also erase the memories stored in both zones by pressing the memory recall key for more than 5 seconds.

## Troubleshooting


If a problem should arise during use, please check the following points.

Symptom	Check Point	Correction
No display when the POWER button is pressed	Have the batteries run down?	Replace them with 2 new "AAA" alkaline batteries
	Have the batteries been properly positioned in the compartment?	Re-insert the batteries in the correct position
EE mark shown on the display or the blood pressure value is displayed excessively low (or high)	Is the cuff placed correctly?	Wrap the cuff properly so that it is positioned correctly
	Did you talk or move during the measurement?	Measure it again quietly
	Did you shake the wrist with the cuff on it?	

**Note:** If the unit still does not work, please see the Warranty Information in this manual.  
Under no circumstance should you disassemble the unit and attempt repairs yourself.



## Precautionary Notes:

1. Your Health o meter<sup>®</sup> monitor contains high-precision components. Therefore, avoid extreme temperatures, humidity, and direct sunlight. Avoid dropping or sharp impacts to the main unit, and protect it from dust.
2. Clean the blood pressure monitor body and the cuff carefully with a slightly dampened soft cloth. Do not press on the unit too hard. Do not wash the cuff or use chemical cleaners on it. Never use thinner, alcohol or petrol (gasoline) as cleaner.
3. Leaky batteries can damage the unit. Remove the batteries when the unit is not used for an extended period of time.
4. Do not press the ON/OFF/START key  when the cuff is not placed around the wrist.
5. To avoid hazardous situations, the unit should not be operated by children.
6. Do not disassemble the main unit or cuff.
7. If the unit is stored near a freezing temperature, allow it to acclimate at room temperature before use.
8. Your Health o meter<sup>®</sup> Blood Pressure Monitor is not field serviceable. You should not use any tool to open the device nor should you attempt to make any adjustments to it. If the monitor is not working properly please contact Sunbeam Products, Inc. as outlined under the Warranty information in this manual.
9. For users diagnosed with common arrhythmia (*atrial or ventricular premature beats or atrial fibrillation*), diabetes, poor circulation of blood, kidney problems, or for users who have suffered from stroke, or for unconscious users, this device may not be suitable for use. Please consult your physician prior to use.

## Specifications:

Power Source	: 3V DC Two (AA) Alkaline Batteries
Measurement Method	: Oscillometric
Measurement Range	: Pressure: 20~280mmHg : Pulse: 40~180 beats/ minute
Accuracy	: Pressure: $\pm$ 3mmHg : Pulse: $\pm$ 5% of reading
Pressure Sensor	: Semiconductor
Inflation	: Pump Driven Inflation
Deflation	: Automatic Pressure Release Valve
Memory capacity	: 50 memories for each of 2 zones
Auto-shut-off	: 1 minute after last button operation
Operation Environment	: Temperature: 5°C ~ 45°C (41°F~101.3°F); 40 ~ 85% RH max.
Storage Environment	: -10°C ~ 60°C (14°F~140°F) 10 ~ 95% RH max.
Weight	: 130 g (without batteries)
Wrist Circumference	: 13.5 ~ 22 cm (5.3 inches ~ 8.7 inches)
Limited patient	: Over 18 years old
Dimensions	: 79 (L) x 72 (W) x 71 (H) mm [3.1 in (L) x 2.835 in (W) x 2.795 in (H)]
K.B.	: Short time operation is 2 minutes : Classification of type BF

*\*To ensure accurate measurements, it is recommended that calibration be completed every two years.*

*\*Specifications are subject to change without notice.*

## Patents:

The Health o meter<sup>®</sup> Model 7632 is patented in countries named below:

Germany :	# 295-11-738.9 # 297-21-574.4
Japan :	# 3020497
Taiwan :	# 140134
Mainland China :	# ZL 95217421.9 # ZL 97249758.7

The Health o meter<sup>®</sup> Model 7632 is patent pending in other countries.

## Warranty Information

Your Health o meter® Blood Pressure Monitor is covered under the limited Warranty offered by Sunbeam Products, Inc. ("Sunbeam"). Sunbeam warrants that for a period of five years from the date of purchase, this product will be free from defects in material and workmanship. Sunbeam, at its option, will repair or replace this product or any component of the product found to be defective during the warranty period. Replacement will be made with a new or remanufactured product or component. If the product is no longer available, replacement may be made with a similar product of equal or greater value. This is your exclusive warranty. This warranty is valid for the original retail purchaser from the date of initial retail purchase and is not transferable. Keep the original sales receipt. Proof of purchase is required to obtain warranty performance. Sunbeam dealers, service centers or retail stores selling Sunbeam Products do not have the right to alter, modify or in any way change the terms and conditions of this warranty.

This warranty does not cover normal wear of parts or damage resulting from any of the following: negligent use or misuse of the product, use on improper voltage or current, use contrary to the operating instructions, disassembly, repair or alteration by anyone other than Sunbeam or an authorized service center. Further, the warranty does not cover Acts of God or Nature, such as fire, flood, hurricane and/or tornado.

Sunbeam shall not be liable for any incidental or consequential damages caused by the breach of any express or implied warranty. Except to the extent prohibited by applicable law, any implied warranty of merchantability or fitness for a particular purpose is limited in duration to the duration of the above warranty. Some states, provinces or jurisdictions do not allow the exclusion or limitation of incidental or consequential damages or limitations on how long an implied warranty lasts, so the above limitations or exclusion may not apply to you. This warranty gives you specific legal rights, and you may also have other rights that vary from state to state or province to province.

For more information, or to obtain warranty service, contact Sunbeam Products, Inc. at 800 672-5625 or visit the Health o meter® website at [www.healthometer.com](http://www.healthometer.com)

©2002 Sunbeam Products, Inc. All rights reserved.

Health o meter® is a registered trademark of Sunbeam Products, Inc.

and MicroStep™ is a trademark of Sunbeam Products, Inc.

Distributed by Sunbeam Products, Inc., Boca Raton, FL 33431.

Manual printed in China.

# BLOOD PRESSURE LOG

Name: \_\_\_\_\_

My Target Blood Pressure is: \_\_\_\_\_

I am to call my healthcare practitioner:

if my blood pressure goes above \_\_\_\_\_ or falls below \_\_\_\_\_.

if I have the following symptoms: \_\_\_\_\_

<u>DATE</u>	<u>TIME</u>	<u>BLOOD PRESSURE</u>	<u>COMMENTS</u>
_____	_____	____/____	_____
_____	_____	____/____	_____
_____	_____	____/____	_____
_____	_____	____/____	_____
_____	_____	____/____	_____
_____	_____	____/____	_____
_____	_____	____/____	_____
_____	_____	____/____	_____
_____	_____	____/____	_____
_____	_____	____/____	_____
_____	_____	____/____	_____
_____	_____	____/____	_____
_____	_____	____/____	_____
_____	_____	____/____	_____
_____	_____	____/____	_____
_____	_____	____/____	_____
_____	_____	____/____	_____
_____	_____	____/____	_____
_____	_____	____/____	_____
_____	_____	____/____	_____
_____	_____	____/____	_____
_____	_____	____/____	_____

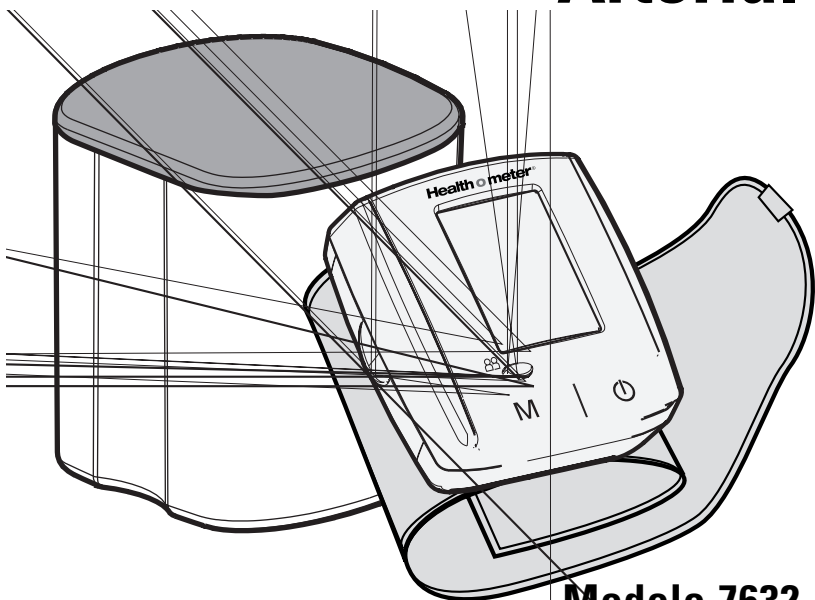


# Health o meter®

*Your Measure for Good Health™*

AUTOMÁTICO DE MUÑECA

## Medidor de Presión Arterial



**Modelo 7632**

## NOTAS IMPORTANTES

Lea por favor este manual entero cuidadosamente antes de usar este dispositivo.

# Healthometer®

## Automático de Muñeca Medidor de Presión Arterial

### INSTRUCCIONES DE MEDIDAS IMPORTANTES

#### NO DESTRUYA

#### Características:

- Operación de Un Toque
- Pantalla Digital Grande, Fácil de Leer
- Característica de Memoria para Dos Usuarios
- 50 Lecturas de Memoria Automáticas para Cada Usuario
- Tecnología MicroStep™ Controla el Desinflado con Precisión para una Mayor Exactitud
- Indicador del Día y la Hora
- Se Apaga Automáticamente
- Caja de Almacenamiento muy Conveniente
- Compacto y Portátil

*De Conformidad con Estándares Internacionales:*

CE ISO  
0366 9001

## Índice

Introducción .....	4
Guía de Referencia Rápida .....	5
Estándares de Calidad .....	6
Acerca del Monitor de Muñeca .....	6
Acerca de la Presión Arterial .....	6-7
Estándar de Presión Arterial .....	7
Fluctuaciones de la Presión Arterial .....	7
Caja para su Transporte .....	8
Identificación de los Componentes del Producto .....	8
Descripción de la Pantalla .....	9
Instalación de las Baterías .....	9-10
Ajuste de la Hora .....	10
COMO SE USA .....	11-15
• Consejos Útiles .....	11
• Colocación del Brazaletes .....	11
• Postura Apropiaada Durante la Medición .....	12
• Tomando una Medición .....	13-14
• Lectura de las Memorias .....	14-15
• Borrado de los Valores de la Memoria .....	15
Solución de Problemas .....	16
Precauciones .....	17
Especificaciones .....	18
Patentes .....	18
Información sobre la Garantía .....	19
Diario de Presiones Arteriales .....	20-21



# Introducción

Felicitaciones por la compra de su nuevo Monitor de Presión Arterial de Muñeca Health o meter® Modelo 7632. Este aparato totalmente automático, de uso en la muñeca es fácil de usar y muy adecuado para tomar mediciones diarias. La pantalla grande incluye la medición sistólica, la diastólica y la del pulso, todas ellas mostradas claramente una vez que se completa cada lectura. Con sus características ampliadas, completas, su monitor Health o meter® será el único monitor de presión arterial que necesitarán usted y su familia.

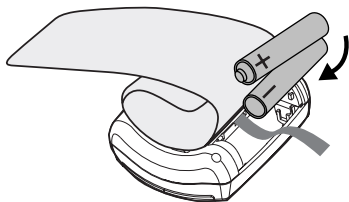
Con este monitor de presión arterial, usted puede almacenar hasta 50 mediciones en 2 Zonas de Memoria, uno para cada usuario. Este aparato es ideal para los usuarios que desean controlar y mantener el seguimiento de su presión arterial de una manera regular. El monitor de presión arterial Health o meter® es compacto y portátil, lo cual lo hace ideal para el uso en el hogar y también durante los viajes.

Las mediciones de la presión arterial encontradas con el monitor de presión arterial Health o meter® son equivalentes a aquellas obtenidas usando el método de auscultación de brazalete y estetoscopio y están dentro de los límites prescritos por el Instituto de Estándares Nacionales Americano (ANSI) Este monitor es para usarse con adultos y está diseñado para uso en el hogar.

Nota: Por favor lea esta manual cuidadosamente antes de usarlo. Para información específica acerca de su propia presión arterial, consulte con su médico. Por favor asegúrese de guardar este manual para futuras consultas.

# Quick Reference

## A. Installing Batteries



Battery Type: 2 AAA 1.5 Volt  
(See Page 9)

## B. Applying the Cuff



Apply cuff to **LEFT** wrist with  
**PALM FACING UP.**  
(See Page 11)

## C. Correct Posture

Place the wrist at heart level.  
(See Page 12) Relax a few minutes  
before starting the Blood Pressure  
Monitor. (See Helpful Tips, Page 11)

## D. Press ON/OFF/START Button

Remain still during measurement.  
This unit will automatically inflate  
then deflate. (See Page 13)

## E. Automatic Memory

Your new Health o meter<sup>®</sup> monitor  
stores a maximum of 50 measured  
values for up to 2 users. The symbol  
“mem” will blink when measurement  
is completed and stored in memory.  
(See Page 14)

## F. Recall Memory

Use **User-Selection** button to  
select a Memory Zone, then press “**M**”  
to recall prior measured values from  
that Memory zone. (See Page 14)

## Estándares de Calidad

Este Monitor de Presión Arterial se ajusta al Instituto de Estándares Nacional Americano / Asociación Americana de Estándares de Instrumentos Médicos para Monitores de Presión Arterial No-Invasivos. Además, el aparato cumple con las regulaciones Europeas y lleva el sello "CE 0366" de la CE. La calidad de este aparato ha sido verificada y se ajusta a las previsiones de la directiva 93/42/EEC del Consejo CE de fecha 14 de Junio de 1993 respecto a aparatos médicos, así como la directiva 89/336/EEC de la EMC.

ANSI/AAMI SB10	Esfigmomanómetros Electrónicos o automáticos
EN 1060-1 (Dic. 1995)	Equipo de medición de la presión arterial no-invasivo Requerimientos Generales
EN 1060-3 (Feb. 1997)	Equipo de medición de la presión arterial no-invasivo Requerimientos suplementarios para sistemas electromecánicos de medición de la presión arterial

## Acerca del Monitor de Presión Arterial de Muñeca

Su monitor de presión arterial Health o meter® blood emplea el método oscilométrico para determinar su presión arterial. Antes que el brazalete empiece a inflarse, el aparato establecerá una línea de referencia de presión de brazalete, equivalente a la presión del aire. La medición de su presión arterial está basada en esta línea de presión de referencia. Una vez que el brazalete se infla para bloquear el pasaje de la sangre por la arteria, se inicia el proceso de desinflado. Durante el desinflado del brazalete de muñeca, la unidad detecta las oscilaciones de la presión generadas entre las pulsaciones del pulso. Cualquier movimiento muscular durante este período de tiempo ocasionará errores en la medición. Después de detectar la amplitud y el declive de las oscilaciones de la presión durante el proceso de desinflado, su monitor Health o meter® determinará para usted la presión sistólica y la diastólica y su pulso será detectado y mostrado al mismo tiempo.

## ACERCA DE LA PRESIÓN ARTERIAL

### ¿Qué es la Presión Arterial?

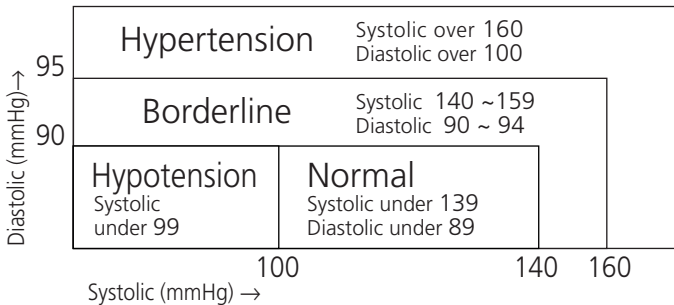
La presión arterial es la presión ejercida contra el interior de la pared arterial durante el flujo de la sangre a través de la arteria. La presión medida cuando el corazón se contrae y envía la sangre fuera del corazón es la lectura "sistólica" (*el número más alto*). La presión medida cuando el corazón se dilata con la sangre fluyendo hacia adentro del corazón es llamada la presión arterial "diastólica" (*número más bajo*).

# Why Measure Your Blood Pressure?

Various health problems associated to high blood pressure are quite common with people in today's society. There is a significant correlation of high blood pressure with cardiovascular disease. This correlation has made measuring blood pressure a necessity for those individuals identified with high blood pressure, placing them into a high risk category pertaining to cardiovascular disease. Also, as a person ages, one's blood pressure can change over time, thus it makes good "health sense" to monitor your blood pressure on a regular basis.

## Blood Pressure Standard

The World Health Organization (WHO) has developed a blood pressure standard, according to which areas of low and high-risk blood pressure are identified. This standard, however, is a general guideline as individual's blood pressure varies among different people and different age groups, etc.

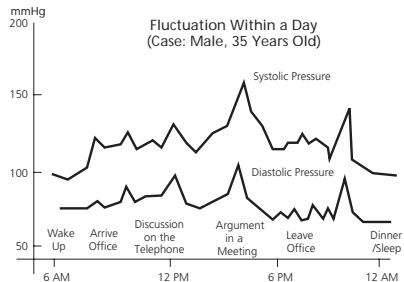


It is important that you consult with your physician regularly. Your physician can tell you your optimal blood pressure range.

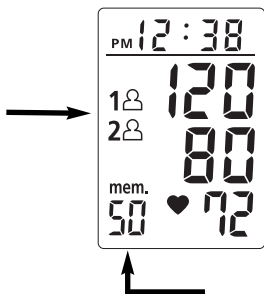
## Blood Pressure Fluctuation

***Blood pressure fluctuates all the time!***

Your blood pressure will change over the course of the month, week and even throughout the day. It is also influenced by seasonal and temperature changes.







## Replace the batteries if:

1. The weak battery mark appears in the display.
2. Nothing appears in the display when the power is switched on.






As the supplied batteries are for test only, they may discharge earlier than batteries you buy in stores. Replace the batteries in pairs.

Remove batteries when unit is not in use for extended periods of time.

Note: Discard used batteries as directed by your local, environmental codes.



## Setting the Time

1. To set/adjust the date and time in the monitor, press the **"Set"** Button  located on the top surface of the monitor. The display will show a blinking number showing the month.
2. Change the month by pressing the  button. Each press of this button will increase the number by one in a cycling manner. Press the **Set Button**  again to confirm the entry, and the screen will show a blinking number representing the number of the day in the month.
3. Change the date, the hour and the minutes as described in Step 2 above, using the  button to change and the  button to confirm the entries.
4. A **"0"** will reappear as the Blood Pressure Monitor is ready for measurement again.



Press the Set Button



Month Position Will Blink



Press To Select Month



Press To Confirm Selection



...s más exactas:  
...comida copiosa.  
...medirse.

...lesca



4. Con el fin de obtener lecturas más exactas, asegúrese de que la correa de la muñeca de modo que el brazalete y la muñeca estén cómodamente ajustados, asegúrese de que la correa de la muñeca esté ajustada correctamente.

**Nota:** Si el brazalete no está ajustado, los valores de mediciones pueden ser incorrectos. No coloque el brazalete demasiado apretado, ya que puede constreñir el flujo fluido de la sangre hacia el corazón.

5. Si su médico le ha diagnosticado con mala circulación en el brazo izquierdo, coloque el brazalete con cuidado en el brazo izquierdo, como lo muestra la Fig. D.



## Proper Posture During Measurement

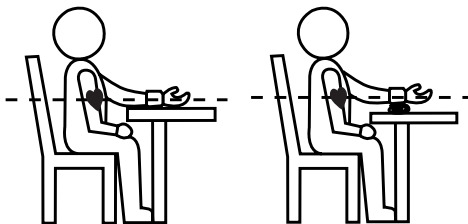
1. Place your elbow on a table so that the cuff is at the same level as your heart as shown in Figure A.

**Note:** Your heart is located slightly below your armpit and a bit to the left of the middle of your chest.

Relax your entire body, especially the area between your elbow and fingers.

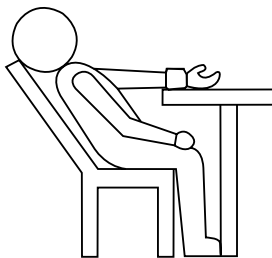


**FIGURE A**



**FIGURE B**

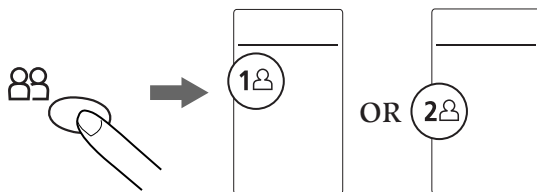
2. If the cuff is not at the same level as your heart or if you can not keep your arm completely still throughout the reading, use a soft object such as a folded towel to support your arm as shown in Figure B. Do not allow hard objects to come in contact with the wrist cuff.
3. Turn your palm upwards.
4. Sit upright in a chair, and take 5-6 deep, relaxing breaths.
5. Avoid leaning back while the measurement is being taken as shown in Figure C.




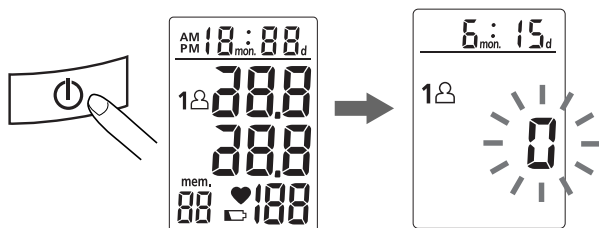
**FIGURE C**

## Tomando una Medición

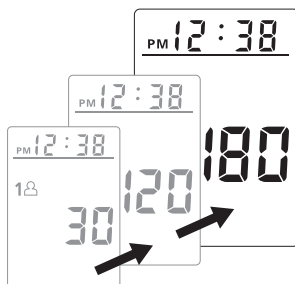
1. Presione el botón “**User Selection**” para seleccionar el Área de Memoria 1 o el Área de Memoria 2. La medición que usted haga automáticamente se almacenará en el área seleccionada.



2. Coloque el brazalete en la muñeca. Presione el botón ON/OFF/START . Todos los dígitos se iluminarán, verificando las funciones de pantalla. El procedimiento de verificación se completará después de unos 2 segundos.

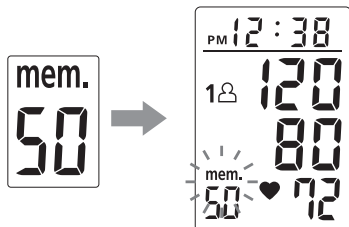


3. Después que todos los símbolos hayan aparecido, la pantalla mostrará un “0” parpadeando. El monitor está “**Listo para Medir**” e inflará **automáticamente** el brazalete para comenzar la medición.



Este monitor se re-inflará **automáticamente a aproximadamente a 220mmHg** si el sistema detectara que su cuerpo necesita una presión mayor para medir su presión arterial.

- When the measurement is completed, systolic, diastolic, and pulse will be shown simultaneously and be saved automatically into the memory. The measurement is then automatically stored into the pre-designated memory zone. **The last 50 measurement readings will be saved into each memory.**

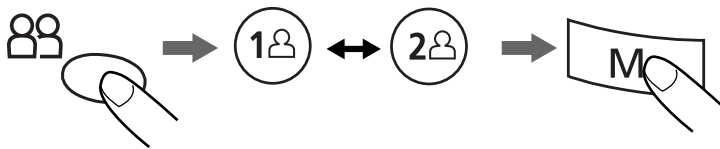


## Note:

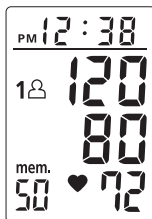
- This monitor automatically switches off approximately **1 minute** after the last button operation.
- To interrupt the measurement, simply press any key. The cuff will deflate immediately after a key is pressed.
- During the measurement, do not talk or move your arm or hand muscles.

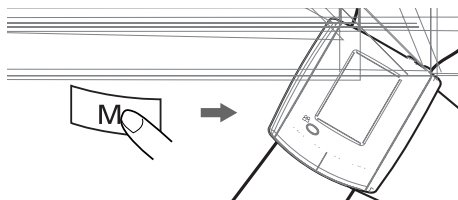
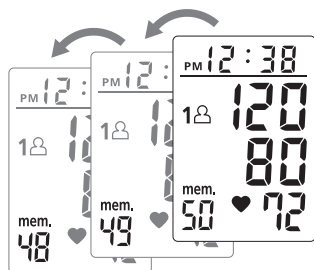
## Recalling Values from Memory

- The monitor has two memory zones (1 and 2). **Each zone can store up to 50 measurements.**



- To recall blood pressure readings from memory, use the **"User-Selection"** button to select the appropriate Memory Zone (1 or 2) from which to recall the readings. Once the proper zone is selected, press the **"M"** button. The memory values will be shown on the LCD display.






## Troubleshooting

If a problem should arise during use, please check the following points.

Symptom	Check Point	Correction
No display when the POWER button is pressed	Have the batteries run down?	Replace them with 2 new "AAA" alkaline batteries
	Have the batteries been properly positioned in the compartment?	Re-insert the batteries in the correct position
EE mark shown on the display or the blood pressure value is displayed excessively low (or high)	Is the cuff placed correctly?	Wrap the cuff properly so that it is positioned correctly
	Did you talk or move during the measurement?	Measure it again quietly
	Did you shake the wrist with the cuff on it?	

**Note:** If the unit still does not work, please see the Warranty Information in this manual.  
Under no circumstance should you disassemble the unit and attempt repairs yourself.

## Precauciones

1. Su monitor Health o meter® contiene componentes de alta precisión. Por lo tanto, evite las temperaturas y la humedad extremas y los rayos directos del sol. Evite dejar caer o los impactos agudos contra la unidad principal, y protéjala contra el polvo.
2. Limpie cuidadosamente el cuerpo del monitor de presión arterial y el brazalete con un paño suave ligeramente humedecido. No presione la unidad con mucha fuerza. No lave el brazalete ni utilice limpiadores químicos. Nunca utilice solvente (thinner), alcohol ni derivados del petróleo (gasolina) como limpiador.
3. Las baterías con fugas pueden dañar la unidad. Quite las baterías cuando la unidad no esté en uso por un largo período de tiempo.
4. No presione el botón ON/OFF/START  cuando el brazalete no esté colocado alrededor de la muñeca.
5. Para evitar situaciones peligrosas, la unidad no debe ser operada por niños.
6. No desarme la unidad principal ni el brazalete.
7. Si la unidad estuviera almacenada cerca a la temperatura de congelación, deje que se aclimate primero la temperatura de la habitación antes de emplearla.
8. Su Monitor de Presión Arterial Health o meter® no puede ser reparado por el usuario. Usted no debe utilizar ninguna herramienta para abrir la unidad ni tampoco debe intentar hacerle ningún tipo de ajustes. Si el monitor no estuviera funcionando apropiadamente por favor contacte a Sunbeam Products, Inc. como se describe más abajo en Información de Garantía de este manual.
9. Para los usuarios diagnosticados con arritmia común (*latidos prematuros del atrio o ventriculares o fibrosis del atrio*), diabetes, mala circulación o problemas de la sangre o de los riñones, o para los usuarios que hayan sufrido de derrames, o los usuarios inconscientes, este artefacto puede no ser adecuado para usted. Por favor consulte con su médico antes de su empleo.

## Specifications:

Power Source	: 3V DC Two (AA) Alkaline Batteries
Measurement Method	: Oscillometric
Measurement Range	: Pressure: 20~280mmHg : Pulse: 40~180 beats/ minute
Accuracy	: Pressure: $\pm$ 3mmHg : Pulse: $\pm$ 5% of reading
Pressure Sensor	: Semiconductor
Inflation	: Pump Driven Inflation
Deflation	: Automatic Pressure Release Valve
Memory capacity	: 50 memories for each of 2 zones
Auto-shut-off	: 1 minute after last button operation
Operation Environment	: Temperature: 5°C ~ 45°C (41°F~101.3°F); 40 ~ 85% RH max.
Storage Environment	: -10°C ~ 60°C (14°F~140°F) 10 ~ 95% RH max.
Weight	: 130 g (without batteries)
Wrist Circumference	: 13.5 ~ 22 cm (5.3 inches ~ 8.7 inches)
Limited patient	: Over 18 years old
Dimensions	: 79 (L) x 72 (W) x 71 (H) mm [3.1 in (L) x 2.835 in (W) x 2.795 in (H)]
K.B.	: Short time operation is 2 minutes : Classification of type BF

*\*To ensure accurate measurements, it is recommended that calibration be completed every two years.*

*\*Specifications are subject to change without notice.*

## Patents:

The Health o meter<sup>®</sup> Model 7632 is patented in countries named below:

Germany :	# 295-11-738.9 # 297-21-574.4
Japan :	# 3020497
Taiwan :	# 140134
Mainland China :	# ZL 95217421.9 # ZL 97249758.7

The Health o meter<sup>®</sup> Model 7632 is patent pending in other countries.

## Información Sobre la Garantía

Su Monitor de Presión Arterial Health o meter® está cubierto por la Garantía limitada ofrecida por Sunbeam Products, Inc. ("Sunbeam"). Sunbeam Products, Inc. ("Sunbeam") garantiza que por un período de cinco años a partir de la fecha de la compra, este producto estará libre de defectos en material y mano de obra. Sunbeam, a su opción, reparará o substituirá este producto o cualquier componente del producto que se encuentre defectuoso durante el período de la garantía. El reemplazo será hecho con un producto o componente nuevo o remanufacturado. Si el producto ya no estuviera disponible, el reemplazo se puede hacer con un producto similar de valor igual o mayor. Esta es su exclusiva garantía. Esta garantía es válida para el comprador minorista original a partir de la fecha inicial de compra al por menor y no es transferible. Guarde el recibo de compra original. La prueba de la compra se requiere para obtener la validez de la garantía. Los distribuidores, los centros de servicio o las tiendas al por menor Sunbeam que venden productos Sunbeam no tienen el derecho de alterar, modificar o de ningún modo cambiar los términos y condiciones de esta garantía.

Esta garantía no cubre el desgaste normal de piezas ni los daños resultantes de cualquiera de los siguientes: uso negligente o mal uso del producto, uso en voltaje o corriente incorrectos, uso contrario a las instrucciones de funcionamiento, desmontaje, reparación o alteración por cualquier persona con excepción de Sunbeam o de un centro de servicio autorizado. Aún más, la garantía no cubre los Actos de Dios o de la Naturaleza, tales como los incendios, las inundaciones, huracanes y / o tornados.

Sunbeam no será responsable por ningún daño fortuito o consecuente causado por el incumplimiento de cualesquiera garantías expresas o implicadas. Excepto hasta donde lo prohíba la ley aplicable, cualquier garantía implicada de comerciabilidad o la adecuación para un propósito particular se limita en la duración a la duración de la garantía antedicha. Algunos estados, provincias o jurisdicciones no permiten la exclusión o la limitación de daños fortuitos o consecuentes o limitaciones sobre cuánto tiempo dura una garantía implicada, de modo que las limitaciones o exclusión anteriores pueden no aplicarse a usted. Esta garantía le da a usted derechos legales específicos, y usted puede también tener otros derechos que varíen de estado a estado o de provincia a provincia.

Para mayor información, o para obtener servicio de garantía, contacte a Sunbeam Products, Inc. en el 1 800 672-5625 o visite las páginas de Internet de Health o meter® website en [www.healthometer.com](http://www.healthometer.com)

©2002 Sunbeam Products, Inc. Todos los derechos reservados  
Health o meter® es una marca registrada de Sunbeam Products, Inc.  
y MicroStep™ es una marca comercial de Sunbeam Products, Inc.  
Distribuida por Sunbeam Products, Inc., Boca Raton, FL 33431.

Manual impreso en China.



# BLOOD PRESSURE LOG

Name: \_\_\_\_\_

My Target Blood Pressure is: \_\_\_\_\_

I am to call my healthcare practitioner:

if my blood pressure goes above \_\_\_\_\_ or falls below \_\_\_\_\_.

if I have the following symptoms: \_\_\_\_\_

<b>DATE</b>	<b>TIME</b>	<b>BLOOD PRESSURE</b>	<b>COMMENTS</b>
_____	_____	____/____	_____
_____	_____	____/____	_____
_____	_____	____/____	_____
_____	_____	____/____	_____
_____	_____	____/____	_____
_____	_____	____/____	_____
_____	_____	____/____	_____
_____	_____	____/____	_____
_____	_____	____/____	_____
_____	_____	____/____	_____
_____	_____	____/____	_____
_____	_____	____/____	_____
_____	_____	____/____	_____
_____	_____	____/____	_____
_____	_____	____/____	_____
_____	_____	____/____	_____
_____	_____	____/____	_____
_____	_____	____/____	_____
_____	_____	____/____	_____
_____	_____	____/____	_____
_____	_____	____/____	_____

